



QRB4

QRB4x-xxxxA with AGK42 flange and  
AGK43 clamp

QRB4x-xxxxB with plug

## Yellow flame detector

## QRB4...

**Yellow flame detector for use with Siemens burner controls, for the supervision of oil flames in the visible light spectrum.  
The QRB4 is used in connection with oil burner controls in intermittent operation.**

**QRB4 and this Data Sheet are intended for OEMs using the QRB4 in or on their products.**

### Use

The QRB4 flame detectors are designed for the supervision of yellow-burning oil flames in connection with burner controls type LME7 (on request), LME8 (on request), LMO, LMV2 and LMV3.  
It is designed for frontal and lateral (90°) illumination.

The maximum spectral sensitivity of the QRB4 is about 540 nm, thus giving full consideration to the maximum level of visible light radiation of yellow-burning oil flames. Since the QRB4 also acquires certain parts of the radiation spectrum of other light sources (boiler room lighting, solar radiation, etc.), the standard regulations regarding safety in connection with extraneous light still apply.

## Supplementary documentation

Product type	Type of documentation	Documentation number
LME7	Data sheet	N7105
	Basic documentation	P7105
LME8	Basic documentation	P7109
LMO	Data sheet	N7130
LMV27.100	Data sheet	N7541
LMV26.300A2	Data sheet	N7547
LMV37.4	Data sheet	N7546
LMV36.300A2	Data sheet	N7547
LMV36.520A1	Data sheet	N7544

## Warning notes



**To avoid personal injury or damage to property or the environment, the following warning notes must be observed.**

**It is not permitted to open, interfere with or modify the flame detector, or to replace the connecting cable.**

- All activities (mounting, installation, service work, etc.) must be performed by qualified staff
- Before carrying out any wiring changes in the connection area, isolate the plant from power supply (all-polar disconnection). Ensure that the plant cannot be inadvertently switched on again and that it is indeed dead. If this is not observed, there is a risk of electric shock
- Take suitable measures to provide protection against accidental contact at the electrical connections. If this is not observed, there will be a risk of electric shock
- Each time work has been carried out (mounting, installation, service work, etc.), check to ensure that wiring is in an orderly state and make the safety checks as described in *Commissioning notes*. If not observed, the safety functions are no longer ensured and there will be a risk of electric shock
- Fall, shock or damage to the housing can adversely affect the safety functions. Such detectors must not be put into operation even if they do not exhibit any damage. If not observed, the safety functions are no longer ensured and there will be a risk of electric shock

## Mounting notes

Ensure that the relevant national safety regulations are complied with.

## Installation notes

- Always run the detector cable separate from other cables, especially from high-voltage ignition cables, while observing the greatest possible distance.

It is important to achieve practically disturbance- and loss-free signal transmission:

- Never run the detector cable together with other cables
  - Line capacitance reduces the magnitude of the flame signal
  - Use a separate cable
- Observe the permissible detector cable lengths; refer to *Technical data*

## Commissioning notes

- The intensity of the radiation of light on site is checked by measuring the detector current
- For information about the measuring circuit and the minimum detector current values required, refer to the Data Sheet of the relevant type of burner control

Measuring circuit for detector current measurement

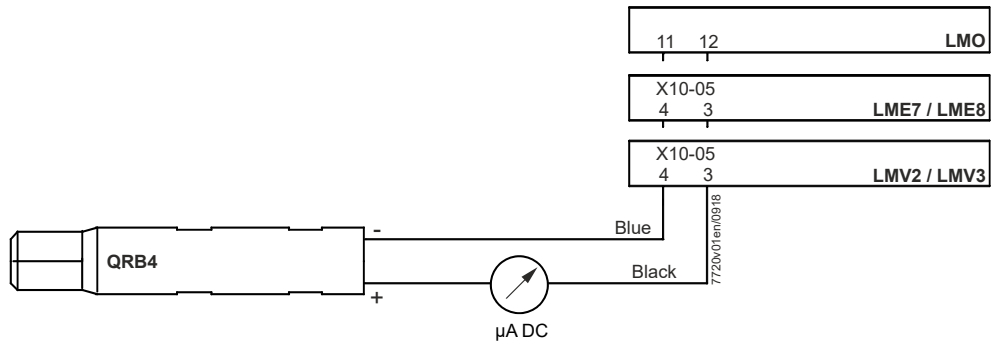

**Caution!**  
It is essential to observe the correct polarity.

## Standards and certificates



Note!  
Only in connection with burner control.



EAC Conformity mark (Eurasian Conformity mark)



ISO 9001:2015  
ISO 14001:2015  
OHSAS 18001:2007



China RoHS  
Hazardous substances table:  
<http://www.siemens.com/download?A6V10883536>

## Service notes

When cleaning the detector, never use burner cleansing spray. Always use a clean and dry cloth to clean the QRB4.

## Disposal notes

The QRB4 contains electrical and electronic components and must not be disposed of together with domestic waste.  
Local and currently valid legislation must be complied with.

## Design

---

General	Compact QRB4 with infused 2-wire thermoplastic cable. The detector is available with normal or high sensitivity and with or without flange / clamp or soft plastic plug (refer to <i>Type summary</i> ).
QRB4x-xxxx	Yellow flame detector without accessories.
QRB4x-xxxxA	<ul style="list-style-type: none"><li>• Secured with an AGK42 flange</li><li>• A guide groove in the flange and a cam on the clamp ensure vibration-free mounting of the QRB4 and make certain that the QRB4 is always correctly sited towards the flame</li><li>• AGK42 flange with 36 mm spacing, plastic version → Included in scope of delivery</li><li>• AGK43 clamp, plastic version → Included in scope of delivery</li></ul>
QRB4x-xxxxB	<ul style="list-style-type: none"><li>• With soft plastic plug</li><li>• For mounting on the burner. All this requires is a hole with a lateral groove; refer to <i>Dimensions</i></li><li>• The sealing and securing ribs of the soft plastic plug hold the QRB4 firmly in the hole</li><li>• A guide spring guarantees correct alignment of the QRB4 with the flame</li></ul>
Accessories QRB4	<ul style="list-style-type: none"><li>• AGK42 flange with 36 mm spacing, plastic version</li><li>• AGK43 clamp, plastic version</li><li>• AGK44 flange with elongated hole</li></ul>



## Type summary

### QRB4

Article no	Type	Sensitivity / casing color		Casing length (G) (mm)	Visible cable length (L) (cm)	Stripped length (M) (mm)	Cable end		Accessories	
		Normal / black	High / red				Ferrule	Stripped	Included: AGK42 flange and AGK43 clamp	Mounted: Plug
S55723-S201-A100	QRB4A-B036A25	●	---	68	36	25	---	---	---	---
S55723-S223-A100	QRB4A-B036B40	●	---	68	36	40	●	●	---	---
S55723-S210-A100	QRB4A-B036B40B	●	---	68	36	40	●	●	---	●
S55723-S202-A100	QRB4A-B050B70	●	---	68	50	70	●	●	---	---
S55723-S207-A100	QRB4A-B050B70A	●	---	68	50	70	●	●	●	---
S55723-S211-A100	QRB4A-B050B70B	●	---	68	50	70	●	●	---	●
S55723-S203-A100	QRB4A-B070B70	●	---	68	70	70	●	●	---	---
S55723-S208-A100	QRB4A-B070B70A	●	---	68	70	70	●	●	●	---
S55723-S212-A100	QRB4A-B070B70B	●	---	68	70	70	●	●	---	●
S55723-S219-A100	QRB4A-B110B70	●	---	68	110	70	●	●	---	---
S55723-S204-A100	QRB4A-B150B70	●	---	68	150	70	●	●	---	---
S55723-S226-A100	QRB4A-B150B70A	●	---	68	150	70	●	●	●	---
S55723-S225-A100	QRB4A-B150B70B	●	---	68	150	70	●	●	---	●
S55723-S222-A100	QRB4B-B025B40B	---	●	68	25	40	●	●	---	●
S55723-S205-A100	QRB4B-B036A25	---	●	68	36	25	---	---	---	---
S55723-S224-A100	QRB4B-B036B40	---	●	68	36	40	●	●	---	---
S55723-S213-A100	QRB4B-B036B40B	---	●	68	36	40	●	●	---	●
S55723-S206-A100	QRB4B-B050B70	---	●	68	50	70	●	●	---	---
S55723-S209-A100	QRB4B-B050B70A	---	●	68	50	70	●	●	●	---
S55723-S214-A100	QRB4B-B050B70B	---	●	68	50	70	●	●	---	●
S55723-S221-A100	QRB4B-B070B70	---	●	68	70	70	●	●	---	---
S55723-S215-A100	QRB4B-B070B70B	---	●	68	70	70	●	●	---	●
S55723-S216-A100	QRB4B-C036B40	---	●	115	36	40	●	●	---	---
S55723-S217-A100	QRB4B-C036B40B	---	●	115	36	40	●	●	---	●
S55723-S220-A100	QRB4B-D030A25	---	●	147	30	25	---	---	---	---
S55723-S218-A100	QRB4B-D050B40B	---	●	147	50	40	●	●	---	●

## Type summary (continued)

Accessories QRB4  
(version without plug)

	Item	Article no. <sup>1)</sup>	Type
	Flange, 36 mm spacing	S55856-Z401-A100	AGK42
	Clamp	S55856-Z402-A100	AGK43
	Flange, with elongated hole	S55856-Z403-A100	AGK44

<sup>1)</sup> To be specified when ordering individual items

## Ordering

- When ordering, please give type reference according to *Type summary*
- QRB4 with plug is always to be ordered without flange and clamp, and vice versa

Example

- QRB4A-B050B70**  
**S55723-S202-A100**
- Sensitivity: Normal
  - Casing length: 68 mm
  - Visible cable length: 50 cm
  - Stripped length: 70 mm
  - End of cable: With ferrule
  - Without plug
  - Accessories: Without flange and clamp
- QRB4A-B050B70A**  
**S55723-S209-A100**
- As above, but with:
- Accessories: AGK42 flange and AGK43 clamp included
- QRB4A-B050B70B**  
**S55723-S211-A100**
- As above, but with:
- Fitted plug

## Technical data

General unit data	Rated voltage	Max. 10 V
	Safety class	II
	Degree of protection	IP54 (For housing only; not for connections)
	Mounting position	Optional
	Detector cable	Cable included in scope of delivery Stranded copper wire 2 x 0.75 mm <sup>2</sup> Jacket Ø 5.1 mm, PVC Cable length according to <i>Type summary</i>
	Weight (depending on type and accessories)	Approx. 80 g
	Permissible cable lengths	Max. 3 m
	Environmental conditions	<b>Storage</b>
Climatic conditions		Class 1K3
Mechanical conditions		Class 1M2
Temperature range		-20 to +60°C
Humidity		<95% r.h.
<b>Transport</b>		DIN EN 60721-3-2
Climatic conditions		Class 2K2
Mechanical conditions		Class 2M2
Temperature range		-20 to +60°C
Humidity		<95% r.h.
<b>Operation</b>		DIN EN 60721-3-3
Climatic conditions		Class 3K5
Mechanical conditions		Class 3M2
Temperature range		-20 to +60°C
Humidity		<95% r.h.
Installation altitude	Max. 2,000 m above sea level	



### Warning!

**Condensation, formation of ice, and ingress of water are not permitted. Failure to observe this poses a risk of damaging the safety functions and the risk of electric shock.**

## Function

Supervision of light radiation of oil flames in the visible range of the light spectrum. The light-sensitive element of the QRB4 is a photo diode. The output current of the QRB4 increases as the intensity of light increases. The output current is evaluated by the burner control to generate the flame signal.

The QRB4 is designed for frontal and lateral (90°) illumination.

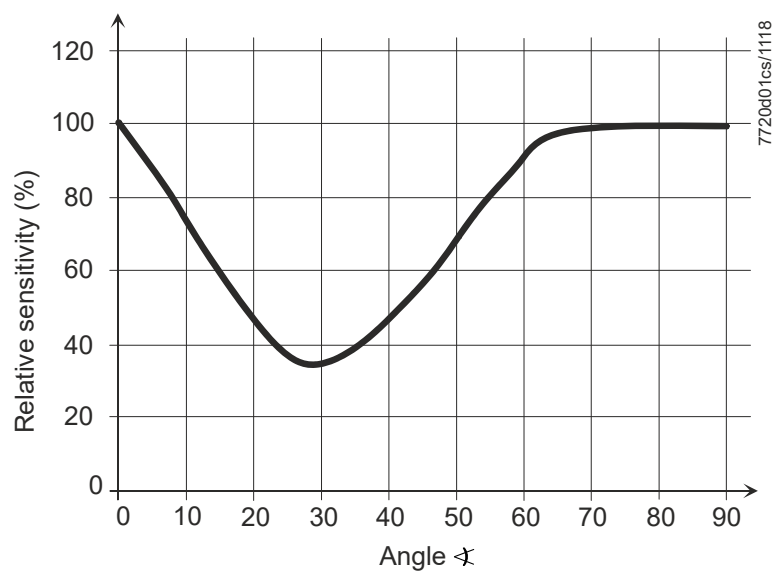



## Dimensions

Dimensions in mm

### QRB4x-B

**QRB4x-Bxxx without plug**

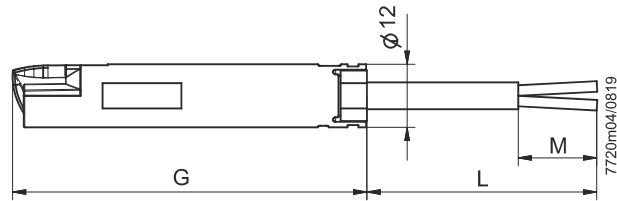

**QRB4x-BxxxB with plug**

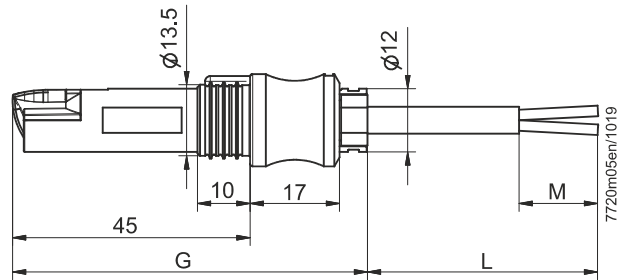

### QRB4x-C

**QRB4x-Cxxx without plug and with extension (40 mm)**

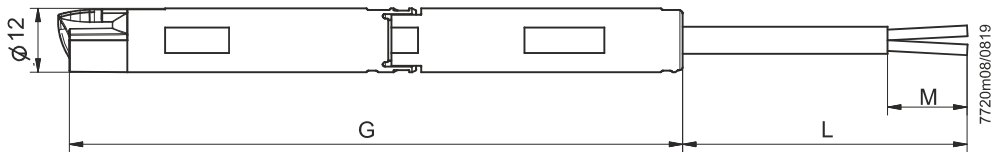

**QRB4x-CxxxB with plug and with extension (40 mm)**

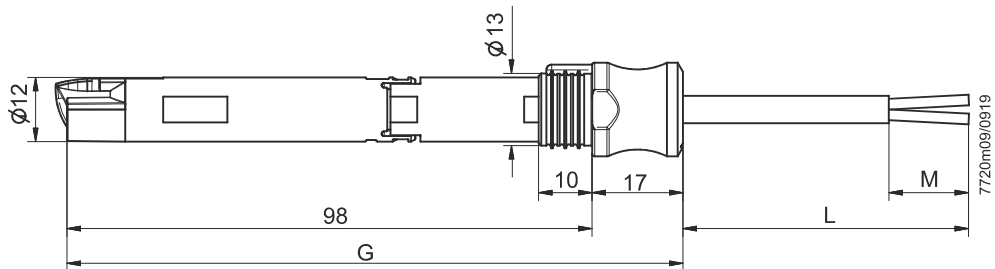

## Dimensions

Dimensions in mm

### QRB4x-D

#### QRB4x-Dxxx without plug and with extension (72 mm)

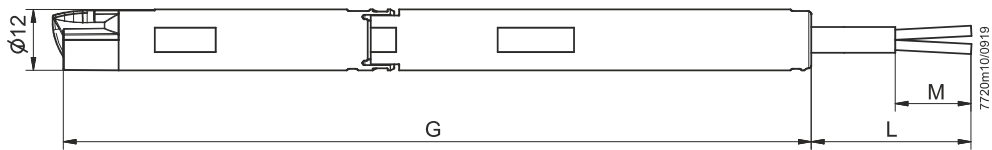

#### QRB4x-DxxxB with plug and with extension (72 mm)

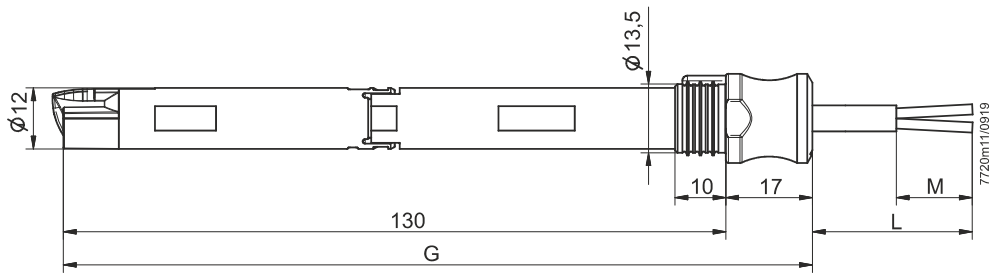

#### Key

- G Housing length, see *Type summary*
- L Visible cable length, see *Type summary*
- M Stripped length, see *Type summary*

#### Fixing hole on the burner chassis

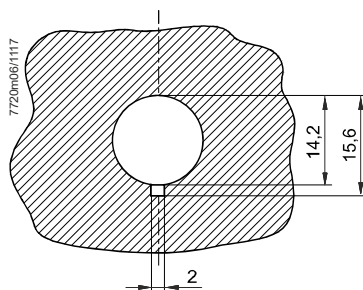

# Dimensions

Dimensions in mm

**Flange  
AGK42**

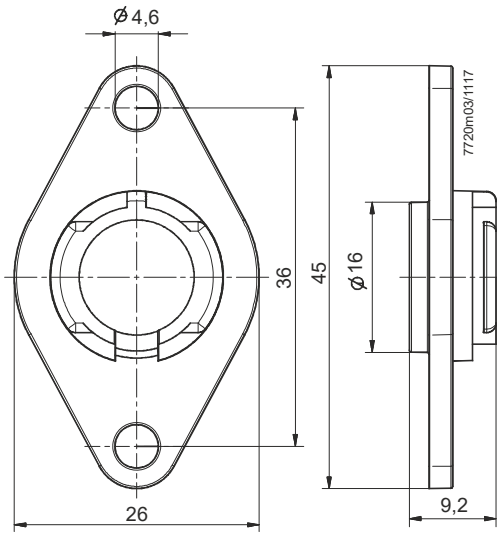

**Clamp  
AGK43**

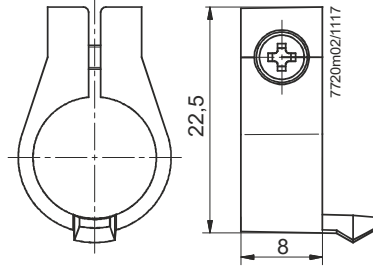

**Flange  
AGK44**

